

MULTI-PORT BALL VALVES

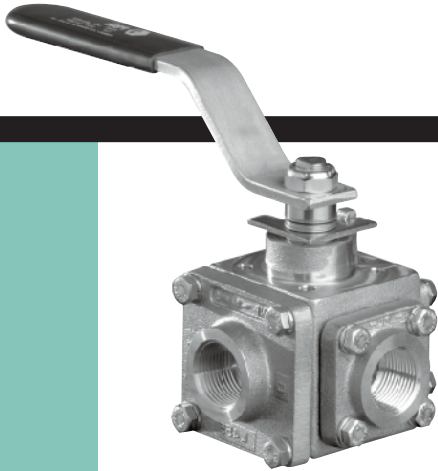

MP Series 1

- Bronze, Iron & Stainless Steel
- 3-, 4-, & 5-Way Valves

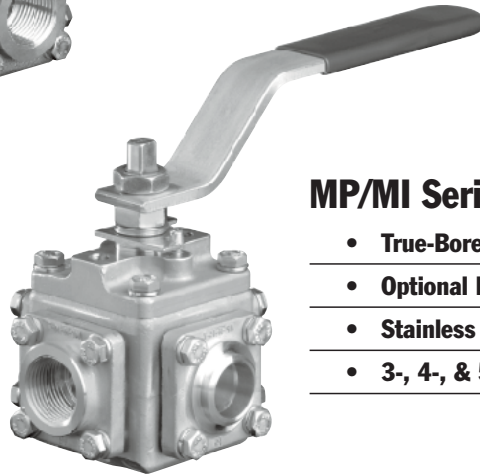

MP/MI Series 4

- True-Bore® or Full-Port
- Optional Body Cavity Fillers
- Stainless & Carbon Steel
- 3-, 4-, & 5-Way Valves

design

engineering

quality

innovation



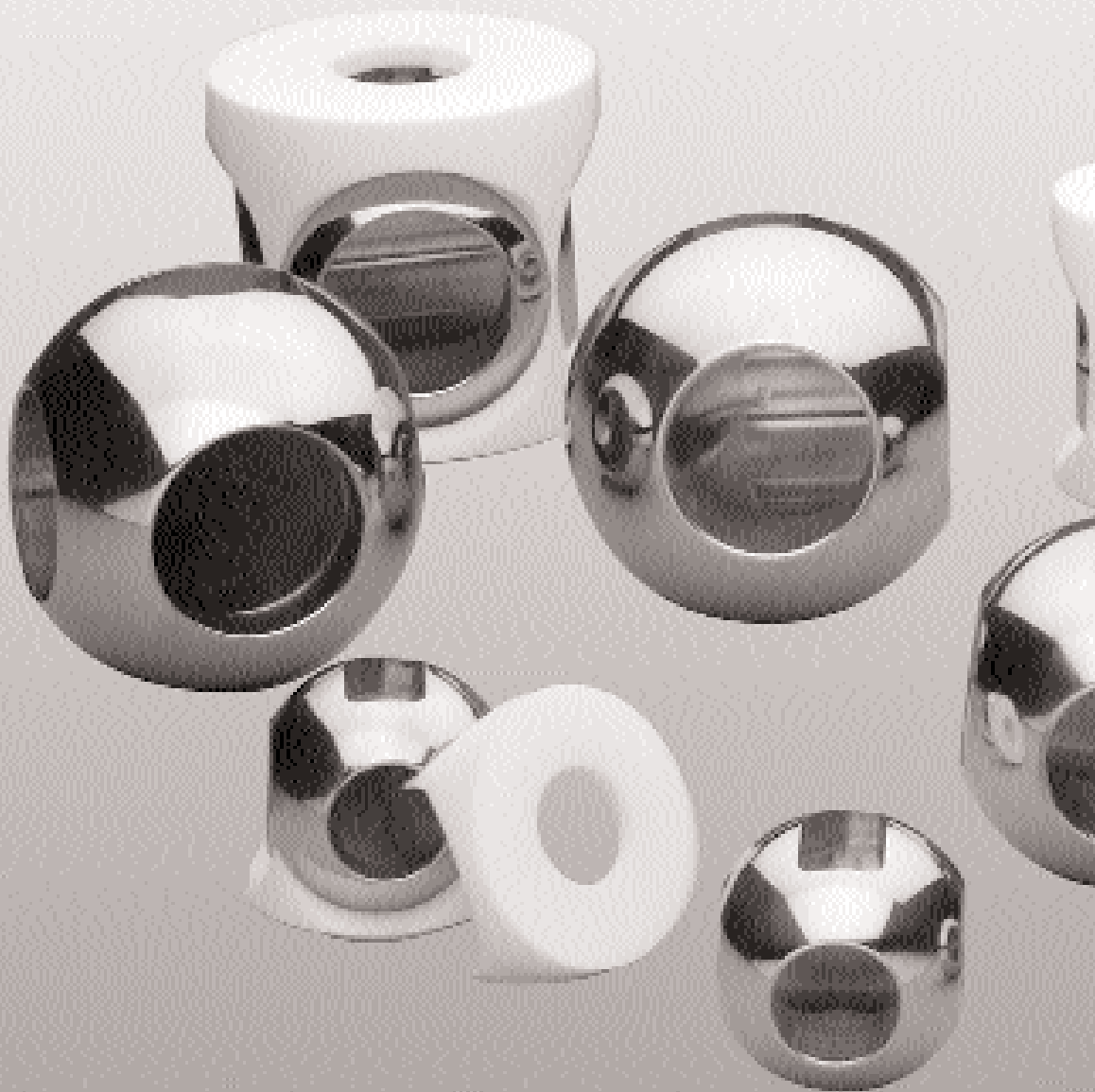

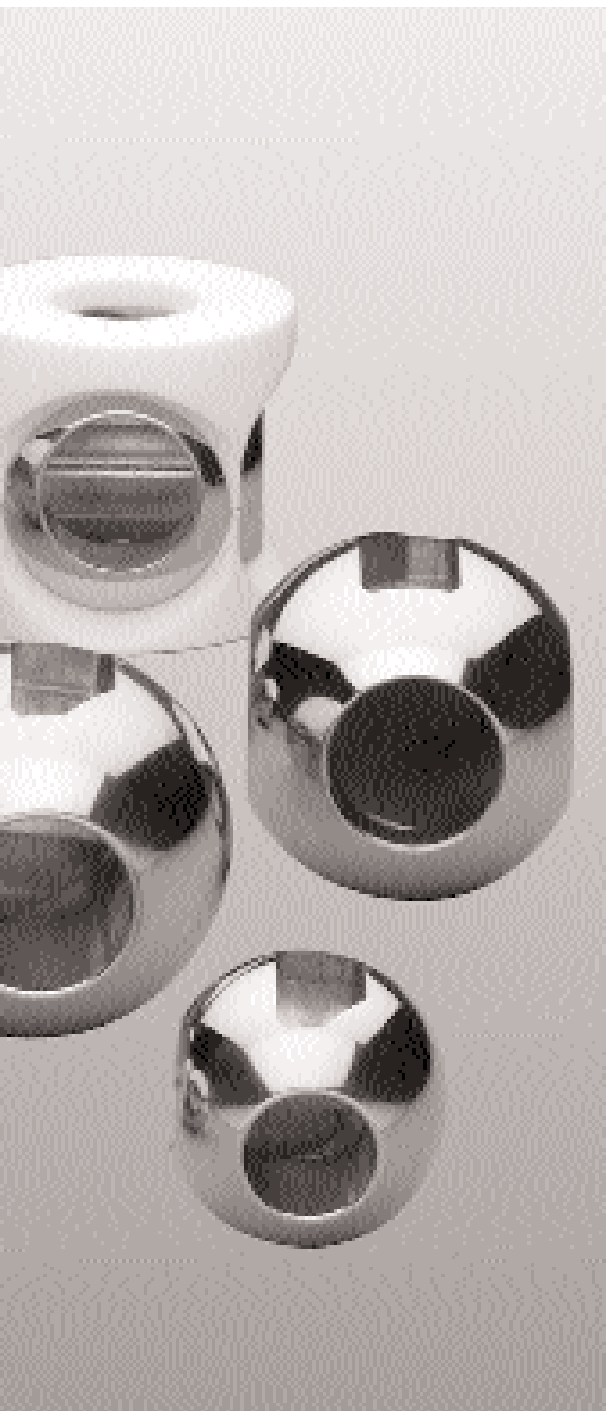

DESIGN FLEXIBILITY

The best way to assure good valve performance is to customize the valve to the process.

PBM offers a comprehensive ball valve line for optimum performance in controlling and automating process lines. Product offerings include 2-Way, Flush Tank, Diverter Port, Multi-Port and specialty ball valves.

Selecting the ideal valve for a process starts with a choice of 18 different metals and alloys for basic valve construction, plus a wide variety of trim and soft part materials. Twenty-three different end fittings are readily available for easy installation without additional unions.

Special options include angle stem flush tank, fire test, actuation, body cavity fillers, sanitary and aseptic valves and special testing. Should an application require a configuration not mentioned, PBM's engineering and manufacturing staff will work with you to design one.

TABLE OF CONTENTS

Anatomy and Design Features — MP/MI Series 4.....	4-5
Adjust-O-Seal® Feature.....	6
True-Bore® Design.....	6
Options — MP/MI Series 4.....	7
MP Series 4 Dimensional Data.....	8
MI Series 4 Dimensional Data.....	9
Metal Materials — MP/MI Series 4.....	10
Allowable Working Pressures — MP/MI Series 4.....	10
Seat & Seal Materials — MP/MI Series 4.....	11
Seat & Seal Pressure/Temperature Ratings — MP/MI Series 4.....	11
C _v Factors — MP/MI Series 4.....	12
Vacuum & Cycle Tests — MP/MI Series 4.....	12
Valve Torque — MP/MI Series 4.....	13
Components — MP/MI Series 4.....	15
Anatomy and Design Features — MP Series 1.....	14-15
Options — MP Series 1.....	15
MP Series 1 Dimensional Data.....	16
Metal Materials — MP Series 1.....	17
Allowable Working Pressures — MP Series 1.....	17
Seat & Seal Materials — MP Series 1.....	18
Seat & Seal Pressure/Temperature Ratings — MP Series 1.....	18
C _v Factors — MP Series 1.....	19
Vacuum & Cycle Tests — MP Series 1.....	19
Valve Torque — MP Series 1.....	20
Components — MP Series 1.....	23
Flow Patterns.....	
Ball & Port Configurations.....	24
3-Way Flow Patterns.....	25
4-Way Flow Patterns.....	26-27
5-Way Flow Patterns.....	27
Ordering Information.....	28-31

ANATOMY OF A SUPERIOR BALL VALVE

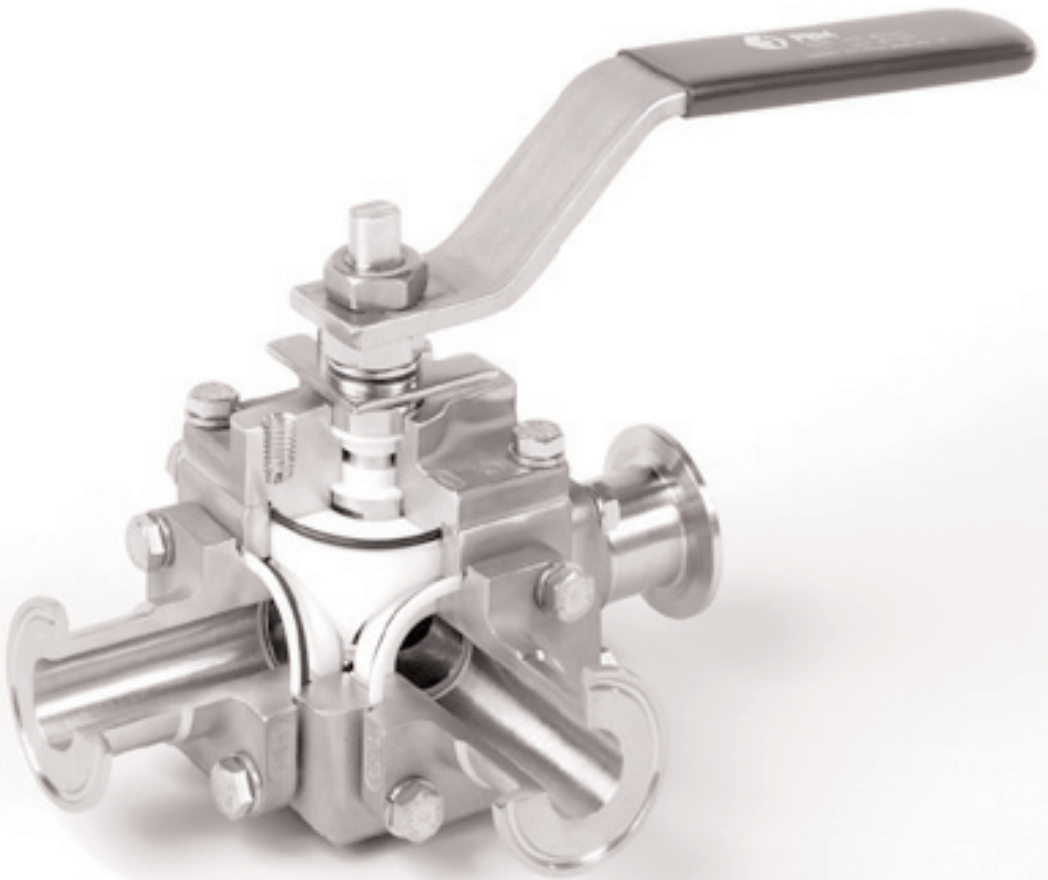

MP/MI Series 4

- The Adjust-O-Seal® design incorporates an engineered space between the valve body and end fittings. This unique feature allows the valve seats to be restored in-line to a leak-tight condition. This adjustment can be repeated several times to compensate for normal wear.
- Internal design produces a bubble-tight seal.
- Spring-loaded washers create an adjustable live-loaded stem assembly for positive sealing.
- Encapsulated seats (MP Series 4) and body gaskets eliminate cold flow (1/2" – 4").
- Standard bottom-entry stem provides protection from inadvertent stem removal. Engagement between the slot and ball is specially suited for high torque applications.
- Indexed ball and stem eliminate incorrect reassembly following routine maintenance.
- Manual safety nuts maintain stem assembly, live-loading, and factory-prepared packing in instances where the handle may be removed for any reason.
- Stainless steel handles with vinyl end covers are designed for a sure grip. Stem markings visually indicate flow direction.
- Stainless steel balls are precision machined and polished to reduce torque and flow resistance, and extend seat life.
- Compact, low profile design facilitates installation in areas with tight space restrictions.
- In some processes, a single Multi-Port ball valve can replace several 2-way valves in a piping system, reducing costs and simplifying flow control with actuation. Multi-Port valves can also be tandem or manifold mounted to further centralize control.
- Transflow, the gradual media flow that occurs as one port opens as another closes, prevents dead-heading and damage to pumps. Note: Transflow will not occur on some bottom entry flow patterns.
- Full-port diameters minimize pressure drops.
- True-Bore® design is standard in MI Series.
- Having either four or five seats ensures tight closure under pressure differentials up to 300 psig.
- Multiple seating in a true Multi-Port valve enables shutoff and directional control in a single valve. Multi-Port valves are ideal for recirculation, mixing, and blending operations.
- Multi-Port valves are ideal for manual or fully automated operation.
- Optional body cavity fillers on 3-, 4-, and 5-way valves minimize areas where media could become trapped and contaminate the process.
- Top entry access on 1/2" thru 4" sizes facilitates inspection and packing replacement.
- Stem assembly accommodates PBM Direct Mount Actuation for improved alignment and increased cycling life.
- Stainless steel brackets are strong, durable, and corrosion-resistant to facilitate wash-down.
- End fitting O-rings on sizes 1/2" thru 4" absorb thermal cycle abuse.

ADJUST-O-SEAL®

The Adjust-O-Seal design allows in-line adjustment to compensate for normal wear on seats and seals. Adjust-O-Seal reduces downtime, maintenance and repair costs, increases valve life, and provides greater sealing.

PBM's Adjust-O-Seal design does not rely on upstream pressure to seal. It provides simultaneous upstream and downstream bubble-tight sealing and in-line seat adjustment.

With the Adjust-O-Seal feature, the valve seats are always compressed against the ball, creating a seal. This seal keeps process media out of the body chamber surrounding the ball. The only process fluid that can enter the body chamber is that which is trapped inside the ball as it moves from one flow position to another.

As the seat and ball wear normally due to valve cycling, the valve can be adjusted in-line to prevent leakage, usually 3-4 times before the seats have to be replaced. This adjustment is accomplished by slightly tightening the body bolts (1/8 turn), which compresses the seats against the ball and restores the valve to a leak-tight condition.

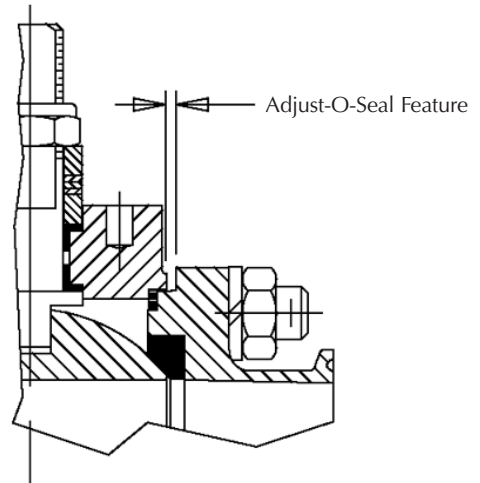

▲ SK-95130A

TRUE-BORE® DESIGN BALL VALVES (MI SERIES 4)

In many applications, it is critical that the flow path pass straight through the valve's ball, seats, and end fittings as though it were one continuous true bore. If a pocket is present, puddling or incomplete drainage of the valve will occur. This puddling of condensate or biological fluids in the ball or end fittings provides an area where bacteria could grow.

True-Bore means that the I.D. of the ball and end fittings is identical to the I.D. of the tubing. Therefore, there are no pockets or dead space in the through path, and no consequent puddling where contamination could develop. The True-Bore design eliminates the temperature fluctuations and pressure drops caused when media flows from tubing or piping through a reduced port ball valve or a full-port ball valve. True-Bore is a standard feature on Igenix® Multi-Port MI Series 4 valves.

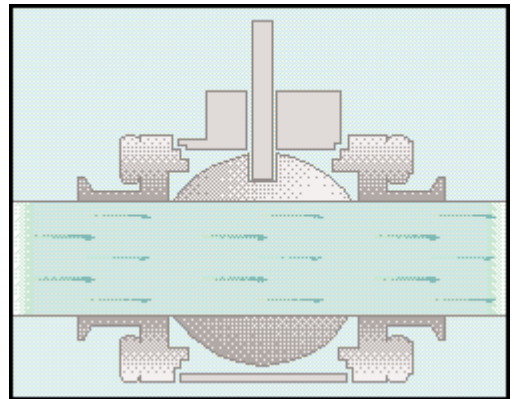

OPTIONS - MP/MI SERIES 4

ASEPTIC

Multi-Port valves for aseptic use are manufactured to customer specifications. Purge and condensate ports are added for CIP/SIP or sampling operations.

▲ SK-96046

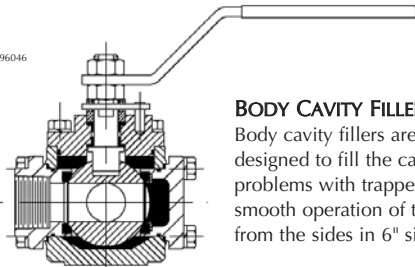

BODY CAVITY FILLERS

Body cavity fillers are made of machined virgin polytetrafluoroethylene (VTFE) and are designed to fill the cavity of the valve between the body and the ball. Cavity fillers minimize problems with trapped fluid in the valve body that could contaminate the process or prevent smooth operation of the valve. Cavity fillers are installed from the top in 1/2" – 4" sizes, and from the sides in 6" size.

ACTUATION

PBM offers a selection of pneumatic and electric actuation packages. PBM valves are designed for Direct Mount Actuation that uses the valve stem as an integral part of the actuator drive and eliminates the need for additional brackets or extensions. This design provides improved cycling life and performance, while reducing the total package profile. PBM can easily Direct-Mount a PBM valve on any actuator with a female drive and an ISO bolt pattern.

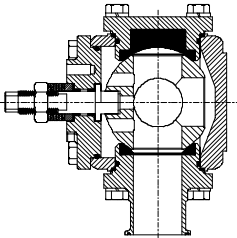

SELF-FLUSHING BALL FEATURE

PBM self-flushing balls join the cavity of the valve with the piping when the valve is open. The holes allow product to fill the cavity just as it fills the piping. When cleaning the lines, the cleaning fluid fills the cavity and displaces the product just as the product is displaced from the piping. No operating features are sacrificed when using self-flushing balls in 3, 4 and 5 way valves.

POLISHING

In addition to aesthetics, mechanical polishing and electropolishing can benefit processing by helping to eliminate rough surfaces where media could become trapped. Electropolishing increases material passivity, improves contamination control, and greatly enhances cleanability of the mechanically polished surface.

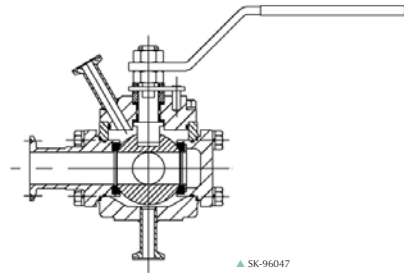

▲ SK-96047

PBM Code	Definition
A	18-23 R _a I.D. Mechanical Polish
B	27-32 R _a O.D. Mechanical Polish
C	18-23 R _a I.D. Mechanical Polish with 27-32 R _a O.D. Mechanical Polish
D	14-18 R _a I.D. Mechanical Polish
E	8-10 R _a I.D. Mechanical Polish
F	Max. 22 R _a I.D. Mechanical Polish with Electropolish
G	Max. 18 R _a I.D. Mechanical Polish with Electropolish
H	Max. 8 R _a I.D. Mechanical Polish with Electropolish
I	Max. 63 R _a I.D. Mechanical Polish
J	6-8 R _a I.D.
K	14-18 R _a I.D. and 27-32 R _a O.D. plus Electropolish

Conversion Chart				
Standard Grit	R _a		RMS	
	μin	μ	μin	μ
150g	27-32	.68-.80	30-35	.76-.89
180g	18-23	.46-.58	20-25	.51-.64
240g	14-18	.34-.46	15-20	.38-.51
320g	8-10	.21-.25	9-11	.23-.28
400g	6-8	.16-.21	7-11	.17-.23

If O.D. is not designated as polish finish, it is investment cast.

RMS: Defined as Root Mean Square roughness, this method measures a sample for peaks and valleys. Lower numbers indicate a smoother finish.

R_a: Known as the Arithmetic Mean, this measurement represents the average value of all peaks and valleys. Lower numbers indicate a smoother finish.

MP SERIES 4 DIMENSIONAL DATA (INCHES)

Multi-Port valves with Female NPT (Q-), Socket Weld for Pipe (U-), Butt Weld for Pipe (B-) and 150# Flange (L-) end fittings.

A	B	C ₁		D ₁		C ₂		D ₂		E	F	G ₁	G ₂	H	I	Approx. (lbs.) S/S	
		Face to Face	Face to Face	Face to Face	Face to Face	Face to Face	Face to Face	Face to Face	Face to Face								
Valve Size	Size Code	Port Dia.	Q-/U-/B-	L-	Q-/U-/B-	L-	Q-/U-/B-	L-	Q-/U-/B-	L-	Handle Top of from \bar{C}	\bar{C} to Bottom Handle	\bar{C} to Bottom Side Entry	\bar{C} to U- Bottom Entry	L- Dia.	Weight Dia.	
1/2"	C	.62	4.5	CF	2.3	CF	4.5	CF	2.3	CF	6.1	2.8	1.5	CF	.9	3.5	7
3/4"	D	.75	4.5	CF	2.3	CF	4.5	CF	2.3	CF	6.1	2.8	1.5	CF	1.0	3.9	7
1"	E	1.00	4.7	7.3	2.3	3.6	4.7	5.7	2.3	3.6	8.1	5.0	1.6	2.3	1.3	4.3	12
1-1/4"	F	1.00	4.7	CF	2.3	CF	4.7	CF	2.3	CF	8.1	5.0	1.6	2.4	1.7	4.6	12
1-1/2"	G	1.50	6.6	10.6	3.3	5.3	6.6	8.6	3.3	5.3	12.1	5.3	2.3	3.3	1.9	5.0	31
2"	H	2.00	7.8	11.9	3.9	6.0	7.6	9.7	3.9	6.0	12.1	5.8	2.6	3.9	2.4	6.0	47
3"	K	3.00	11.7	16.5	5.8	8.2	11.1	13.5	5.8	8.2	Consult PBM ⁶		3.9	5.8	3.5	7.5	133
4"	L	4.00	15.4	19.3	7.7	9.6	14.2	16.2	7.7	9.6	Consult PBM ⁶		4.9	7.7	4.6	9.0	254
6"	M	6.00	16.5	21.5	8.5	12.0	19.9	24.0	10.0	12.0	Consult PBM ⁶		9.5	10.0	6.7	11.0	CF

END FITTING SIZE AVAILABILITY

Item	Stainless Steel	Carbon Steel
Female NPT (Q-)	1/2" - 4"	1/2" - 4"
Socket Weld (U-)	1/2" - 4"	1/2" - 4"
150# Flange (L-)	1/2" - 6"	1/2" - 6"
Butt Weld (B-)	1/2" - 6"	1/2" - 6"

NOTES:

- MP Series valves are also available in 300 lb. Flange (M-) designs.
- I-Line (G-), Male NPT (P-), Camlock (K-) and Grooved (O-) end fittings are also available.
- Stainless steel and carbon steel valves have raised face flanges.
- Using a welded connection for more than one end fitting on an MP Series valve may complicate maintenance. Provisions must be made to allow removal of end fittings and body from the line.
- Cavity fillers in 1/2" - 4" sizes are installed from the top. Cavity fillers in 6" size are installed from the sides.
- Top entry access, 1/2" - 4" sizes. Side entry access, 6" size.
- 1-1/4" and double angle port are not full-port design.
- A gear operator is recommended for 3", 4" and 6" valves. Consult PBM.
- 6" valves do not have O-rings or encapsulated seats.
- Drawings are for illustration purposes only. Consult PBM prior to any fabrication or installation work.
- Approximate weights are for 3-way, side entry, angle port MP Series 4 valves, with female NPT end fittings.

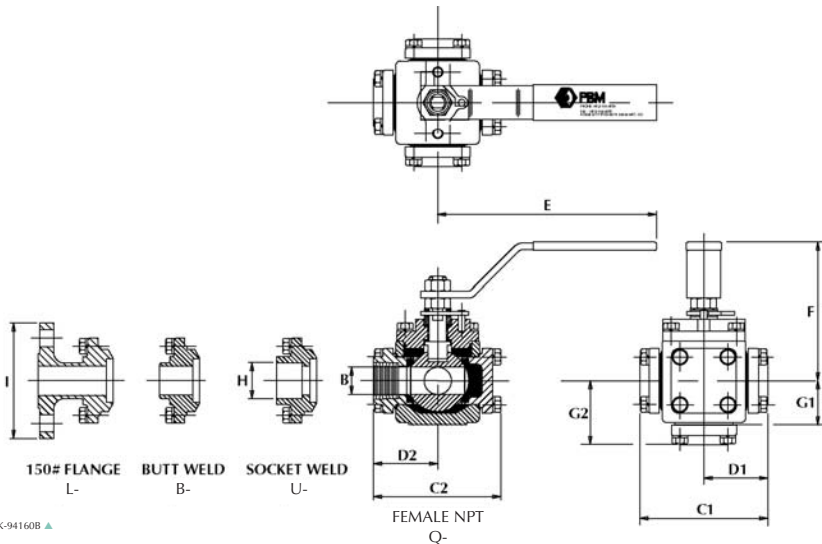

MI SERIES 4 DIMENSIONAL DATA (INCHES)

Multi-Port, True-Bore valves with Tri-Clamp (X-) and Extended Butt Weld (F-) for Tube end fittings.

A	Valve Size	B	C ₁		D ₁		C ₂		D ₂		E	F	G ₁	G ₂	H	Approx. Weight (lbs.) S/S
			Face to Face		℄ to Face		Face to Face		℄ to Face							
			X-	F-	X-	F-	X-	F-	X-	F-						
1/2"	C	.37	5.3	8.3	2.6	4.1	4.9	6.4	2.6	4.1	6.1	2.8	1.5	2.4	1.3	8
3/4"	D	.62	5.3	8.3	2.6	4.1	4.9	6.4	2.6	4.1	6.1	2.8	1.5	2.4	1.3	8
1"	E	.87	7.4	7.4	3.7	3.7	5.7	5.7	3.7	3.7	8.1	5.0	1.6	2.3	1.3	12
1-1/2"	F	1.37	8.5	10.0	4.3	5.0	7.6	8.3	4.3	5.0	12.1	5.3	2.3	3.3	1.3	30
2"	H	1.87	10.1	13.1	5.1	6.6	8.8	10.3	5.1	6.6	12.1	5.8	2.6	3.9	1.3	45
3"	J	2.87	13.2	16.2	6.6	8.1	12.2	13.8	6.6	8.1	CF ⁶		4.1	5.5	1.3	69
4"	K	3.83	16.2	19.1	8.1	9.6	15.0	16.5	8.1	9.6	CF ⁶		5.6	CF	2.3	156
6"	M	5.78	Consult PBM								CF ⁶	Consult PBM				

END FITTING SIZE AVAILABILITY

Item	Stainless Steel
Tri-Clamp (X-).....	1/2" – 6"
Extended Butt Weld (F-).....	1/2" – 6"

F- end fittings through the 3" size match 16 gauge tubing dimensions. 4" size matches 14 gauge tubing dimensions and 6" size matches 12 gauge tubing dimensions.

NOTES:

- Many other end fittings are also available.
- Using a welded connection for more than one end fitting on a MI Series valve may complicate maintenance. Provisions must be made to allow removal of end fittings and body from line.
- Top entry access, 1/2" – 4" sizes. Side entry access, 6" size.
- Cavity fillers in 1/2" – 4" sizes are installed from the top. Cavity fillers in 6" size are installed from the sides.
- F- dimensions are in accordance with ASTM A-269.
- A gear operator is recommended for 3", 4", and 6" valves. Consult PBM.
- Double angle port is not True-Bore design.
- 6" valves do not have O-rings.
- Drawings are for illustration purposes only. Consult PBM prior to any fabrication or installation work.
- Approximate shipping weights for MP Series valves with Female NPT end fittings have been used to estimate shipping weights for valves with X- and F- end fittings.

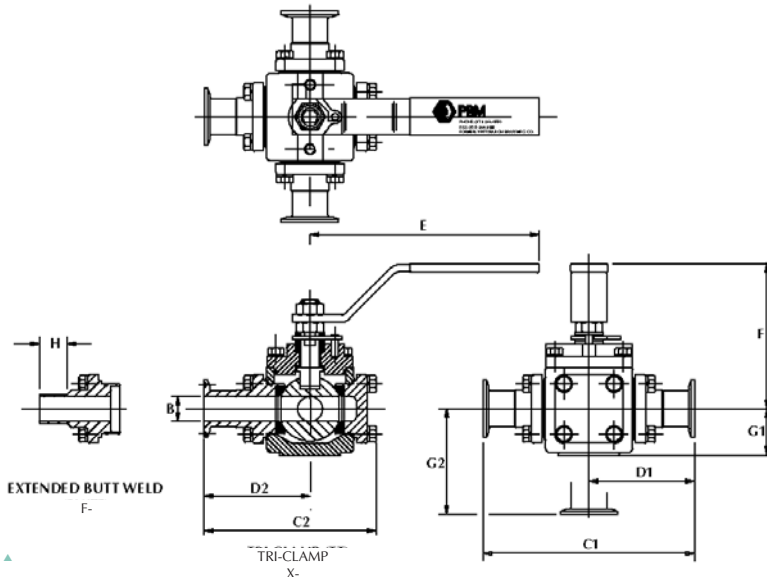

METAL MATERIALS – MP/MI SERIES 4

Process media composition, temperature and application will dictate appropriate metal and soft part materials. Common valve metals for MP/MI Series 4 valves and their general characteristics are listed below.

S/S Stainless Steel (Austenitic Grade), A351-GR-CF8M

316L S/S complies with ASTM A-351-CF3M, 316 S/S complies with ASTM A-351-CF8M.

316 S/S and 316L S/S are exceptionally corrosion-resistant to acidic and basic environments. They do not pit easily and can be polished to a near-mirror finish for the best product release and cleanability.

316L S/S is preferred for sanitary and biotechnological uses. 316L S/S has a carbon content of <.03% to facilitate welding.

Sulfur content in cast BWTE (F-) end fittings is controlled to between .005 and .017%, in accordance with ASME BPE-1997.

Low and zero ferrite materials are also available.

Carbon Steel, A216-WCB

This versatile material efficiently handles mildly corrosive media.

Other

See MP Series 1 (page 19) for bronze and iron.

PBM also manufactures valves fabricated from other metals, including Titanium, Alloy 20, Hastelloy Alloys, Ni-Cu, Cu-Ni, and Inconel.

ALLOWABLE WORKING PRESSURES (PSIG) – MP/MI SERIES 4

Valve Size	Stainless Steel A351, Alloy CF8M or CF3M				Carbon Steel A216 or WCB	
	MP Series 4		MI Series 4		MP Series 4	
	100°F	450°F	100°F	450°F	100°F	450°F
1/2"	900	625	900	675	900	750
3/4"	900	625	900	675	900	750
1"	720	500	720	500	740	615
1-1/4"	720	500	—	—	740	615
1-1/2"	720	500	720	500	740	615
2"	720	500	720	500	740	615
3"	720	500	720	500	740	615
4"	500	350	500	350	500	400
6"	300	190	CF	CF	300	190

NOTES:

1. Temperatures shown are guidelines only, and DO NOT represent the maximum and minimum limits of the valve. Working pressures at temperatures between the minimum and maximum values shown can be interpolated linearly.
2. Seat and seal material ratings may limit allowable pressures and temperatures. For limitations, see page 11.
3. Mechanical clamping devices, such as Tri-Clamp clamps and gaskets, or flanges may lower allowable pressure and temperature values from those shown.

SEAT AND SEAL MATERIALS — MP/MI SERIES 4

Designation	Description	Color	Purpose
RTFE	Glass Reinforced PTFE ¹ PBM standard for seats, seals and stem packings, except for Igenix valves.	Slightly Off-White	Used in a wide variety of applications.
VTFE	Virgin PTFE ¹ PBM standard for Igenix Sanitary Valves and all cavity fillers.	Bright White	Specified for applications requiring low torque, or where other seat & seal composites might contaminate the process. Ideal for sanitary use. FDA compliant.
TFM	Virgin PTFE modified to provide less porosity and yielding.	White	Provides an FDA compliant material with a ruggedness comparable to RTFE with the lower torque requirements of virgin PTFE. Ideal for sanitary use and for low pressure steam service.
S/STFE	Stainless Steel Reinforced PTFE ¹	Dark Gray	Specified for applications requiring slightly higher pressure/temperature ratings or where the process fluid might absorb glass fibers from RTFE. Slightly higher stem torque than RTFE.
PLUS	Glass, Carbon, Graphite & Reinforced PTFE ¹	Charcoal Black	Ideal for higher temperature/pressure applications and/or steam applications. Three times the cyclic lifetime of RTFE.
UHMWPE	Ultra High Molecular Weight Polyethylene	Glossy Off-White	An excellent abrasion and wear-resistant material. Stem torque is similar to RTFE. Maximum temperature rating is 200°F. FDA compliant.
PEEK	Polyetheretherketone	Putty	Recommended for high temperature (up to 550°F)/long wear applications. Includes a special 17-4 PH Stainless Steel stem to accommodate higher stem torques experienced at higher temperatures. Valves cannot be field retrofitted with PEEK. FDA compliant.
KYNAR [®]	Polyvinylidene Fluoride	Slightly Transparent White	High strength polymer suitable for temperatures to 275°F. Often used in radiation-related service and has been exposure tested to 1,000 megarads with minimal property degradation. FDA compliant.

NOTES:

1. PTFE is Polytetrafluoroethylene.
2. With the exception of PEEK, all seating materials meet the Class VI seat leakage criterion of ANSI/FCI 70-2 and the zero leakage criterion of MSS SP-61. For PEEK seats, a criterion of Class V of ANSI/FCI 70-2 applies. PEEK seats are normally not tested with air.
3. Seat and seal materials may be mixed in a valve in order to provide media-compatibility and the appropriate torque, temperature and pressure ratings.
4. MP/MI Series 4 valves are normally furnished with Viton[®] O-rings. For steam and water service, ethylene propylene (EPR) O-rings are recommended. Other O-ring materials are also available. The choice of O-ring materials is dependent on the chemical environment and temperature in the valve. It is important to match the appropriate O-ring material with the service conditions.

SEAT AND SEAL PRESSURE/TEMPERATURE RATINGS — MP/MI SERIES

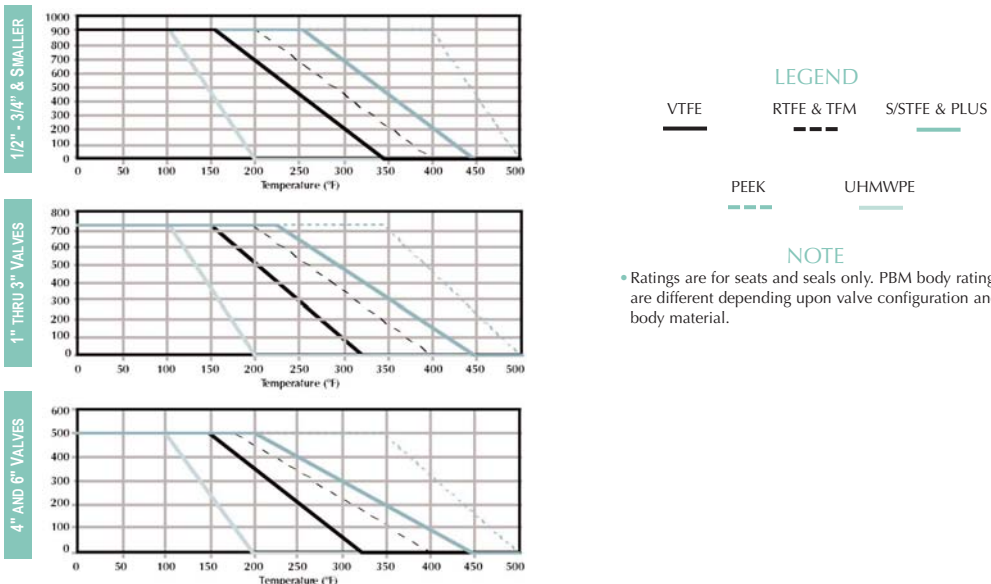

C_V FACTORS — MP/MI SERIES 4

C_V is defined as the number of U.S. gallons of water per minute of ambient temperature water that will flow through a valve at 1 psi pressure drop.

MP SERIES 4 C_V FACTORS (MEASURED IN GPM)

Valve Code	Pipe Size	Port Diameter	L-Port	T-Port Through	T-Port Branched	Double L-Port Side Entry	Double L-Port Bottom Entry	Double T-Port Through	Double T-Port Branched
C	1/2"	.50"	6.2 ²	10.2 ²	5.5 ²	6.2 ²	5.5 ²	10.2 ²	5.5 ²
D	3/4"	.75"	16 ²	23 ²	13.5 ²	16 ²	13.5 ²	23 ²	13.5 ²
E	1"	1.00"	33	38	24	29	33	38	24
F	1-1/4"	1.00"	32 ²	36 ²	24 ²	27 ²	31 ²	36 ²	24 ²
G	1-1/2"	1.50"	78	93	58	67	78	93	58
H	2"	2.00"	148	176	108	124	148	176	108
K	3"	3.00"	380	460	270	300	380	460	270
L	4"	4.00"	680	820	490	530	680	820	490
M	6"	6.00"	1541	1851	1111	1210	1541	1851	1111

NOTES:

1. Most values represent MP Series valves with 150# Flange end fittings.
2. MP Series valves with Female NPT end fittings.
3. Flanged end fittings are not available for F (1-1/4").
4. 1-1/4" and double angle port are not full-port design.

MI SERIES 4 C_V FACTORS (MEASURED IN GPM)

Valve Code	Pipe Size	True-Bore™ Port Diameter	L-Port	T-Port Through	T-Port Branched	Double L-Port Side Entry	Double L-Port Bottom Entry	Double T-Port Through	Double T-Port Branched
C	1/2"	0.37"	3.5	5.3	3.0	3.5	2.9	3.7	2.6
D	3/4"	0.62"	11	16	9.2	11	8.8	11	8.0
E	1"	0.87"	22	33	16	22	18	23	17
G	1-1/2"	1.37"	56	85	49	56	47	60	42
H	2"	1.87"	110	160	93	110	90	110	79
K	3"	2.87"	270	410	240	270	230	290	210
L	4"	3.83"	500	760	440	500	420	540	380
M	6"		Consult PBM						

NOTES:

1. 6" and some double angle port sizes are not True-Bore design.

VACUUM AND CYCLE TESTS — MP/MI SERIES 4

Vacuum Testing

PBM valves are ideally suited for vacuum service. For valves intended for vacuum service, PBM offers optional helium leakage tests of the seats and shell. This test consists of an inboard vacuum test where the exterior of the valve is flooded with helium and, through valve, inward helium leakage is measured. Also, the seats of the valve are helium leakage tested. PBM valves will meet a leakage rate of 1×10^{-6} std. cc/sec. helium leakage for both tests.

Cycle Testing

The life of a ball valve is dependent upon service conditions and, therefore, impossible to predict. However, PBM cycle-tests valves using 100 psid of ambient temperature water pressure across the seats with the valve in the closed position. These test conditions represent a typical wear-causing force on the seats and packings. PBM also tests valves in a hot water environment up to 200°F and in a steam environment up to 380°F.

Replacement of valve gaskets or O-rings is recommended at each disassembly. Replacement of other non-moving parts is dictated only by the corrosion caused by the flow media. In most applications, PBM ball valves will operate trouble-free for many years.

VALVE TORQUE - MP/MI SERIES 4

The figures below are presented as a guide to estimating the forces needed to operate a given sized valve assuming new condition at ambient temperature with a neutral lubricating fluid in the body (such as water) and RTFE seats and seals. When using other seat and packing materials, the stem torque should be proportioned according to the as-built torque of that specific material.

If the process involves abrasive or viscous materials, the use of elevated temperatures, or if the seat or ball of the valve is worn, then an additional margin should be added.

When actuating a valve not factory-actuated by PBM, sufficient margin must be added appropriate to the actuator size.

STEM TORQUE VS. DIFFERENTIAL PRESSURE (NO MARGIN ADDED)

1/2" through 2" Stem Torque, RTFE Seats

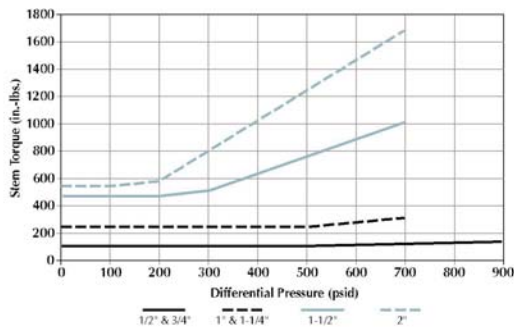

1/2" through 2" Stem Torque, VTFE Seats

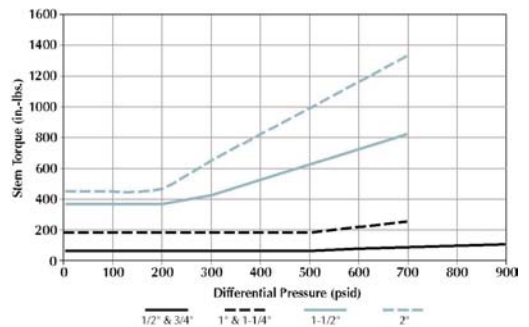

3" and 4" Stem Torque, RTFE Seats

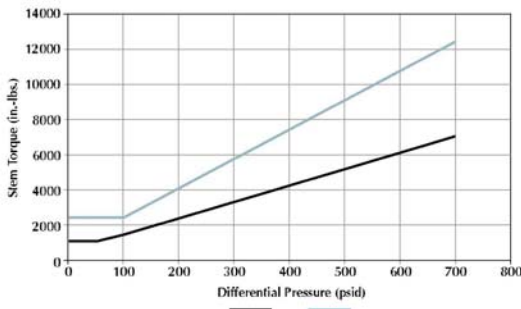

3" and 4" Stem Torque, VTFE Seats

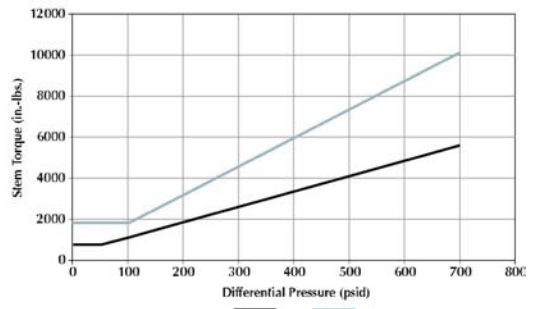

NOTES:

1. Consult PBM for stem torque vs. differential pressure ratings for 6" valves.

NOMINAL TORQUE VALUES - MP/MI SERIES 4

Stem Torque Values (in.-lb.) for MP/MI Series 4 Ball Valves							
Valve Size	Size Code	Valve Stem Breakaway Torque			Minimum Actuator Sizing Torque		
		RTFE, PLUS UHMWPE	S/STFE	VTFE, TFM	RTFE, PLUS UHMWPE	S/STFE	VTFE, TFM
1/2"	C	96	120	77	192	240	154
3/4"	D	96	120	77	192	240	154
1"	E	240	300	192	480	600	384
1-1/4"	F	240	300	192	480	600	384
1-1/2"	G	480	600	384	960	1200	768
2"	H	540	675	432	1080	1350	864
3"	J	1080	1350	864	2160	2700	1728
4"	K	2400	3000	1920	4800	6000	3840
6"	M	Consult PBM			Consult PBM		

NOTES:

1. Stem torque values shown are minimum values and represent ideal conditions (100 psig or less, ambient temperature, with fluid free of suspended solids and comparable in viscosity to water).
2. If valve has not been factory-actuated by PBM, margin must be added appropriate to the actuator size.
3. Torque values are measured at the stem, NOT at the body bolts.
4. For PEEK and KYNAR seat and seal material torque values, consult PBM.
5. 1-1/4" size is available in MP only.

COMPONENTS

Item	Description	Standard Material, PBM Product Series	
		MP Series 4	MI Series 4
A	Body	316 S/S or Carbon Steel	316L S/S
A ₁	Bonnet	316 S/S or Carbon Steel	316L S/S
B	Ball	316 S/S	316L S/S
C ₁	End Fitting	316 S/S	316L S/S
C ₂	Blank Fitting	316 S/S	316L S/S
D	Handle	300 Series S/S	300 Series S/S
E	Stop Disc	300 Series S/S	300 Series S/S
F	Stem	316L S/S	316L S/S
G	Follower	300 Series S/S	300 Series S/S
H	Seat	RTFE	VTFE
I	Stem Packing	RTFE	VTFE
J	Spring Washers (stem)	300 Series S/S	300 Series S/S
K ₁	End Body Gasket	RTFE	VTFE
L	End Fitting O-Ring	Viton	Viton
M	End Fitting Fastener	18-8 S/S	18-8 S/S
O	Lock Washer	18-8 S/S	18-8 S/S
P	Stop Pin	400 Series S/S	400 Series S/S
Q	Handle Cover	Vinyl	Vinyl
S	Hex Nut	18-8 S/S	18-8 S/S
T	Cavity Filler (Option)	VTFE	VTFE
U	Bonnet O-Ring	Viton	Viton

NOTES:

1. Illustrations and parts lists apply to manually-operated MP/MI Series valves.
2. Other materials may be available.
3. Valves prepared for actuator mounting have additional spring washers.

MP SERIES 4

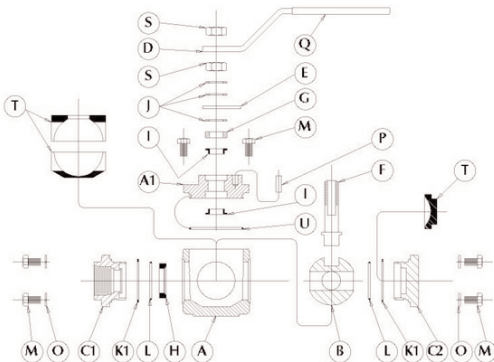

SK-97054 ▲

MI SERIES 4

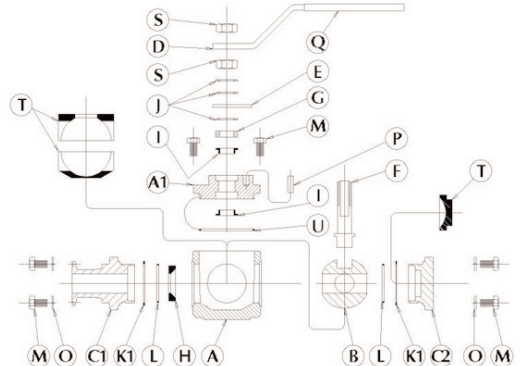

SK-96048A ▲

ANATOMY OF A SUPERIOR BALL VALVE

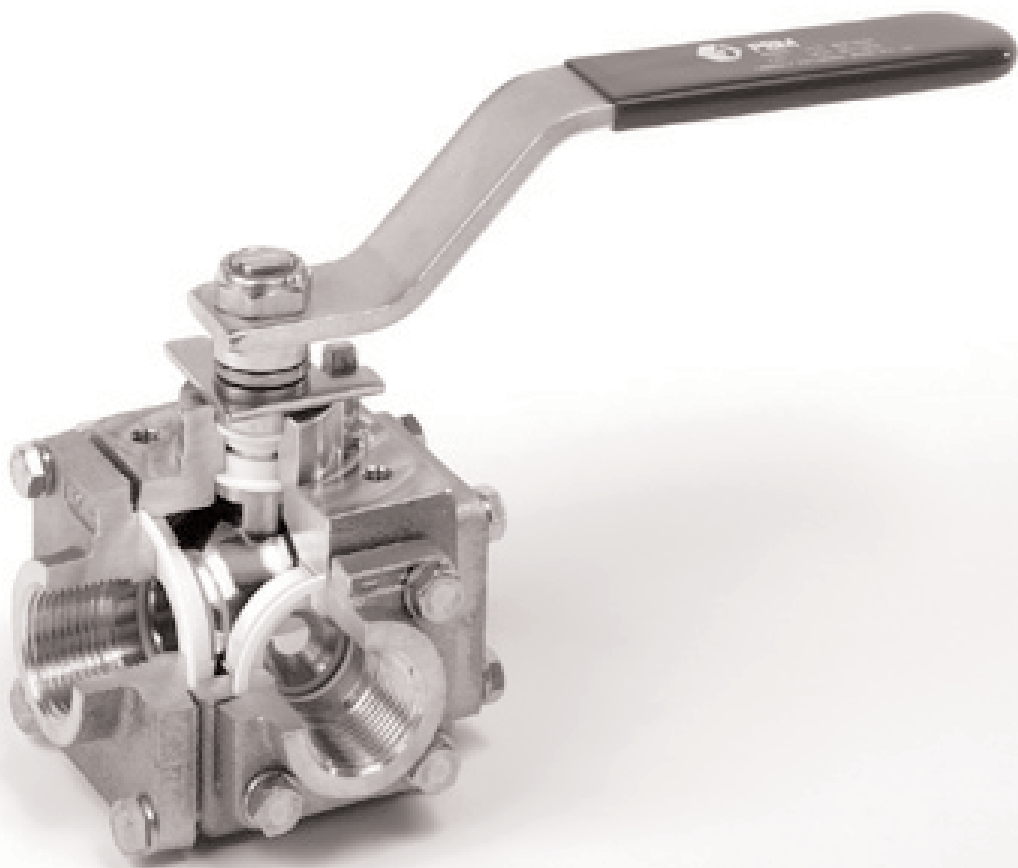

MP Series 1

- The Adjust-O-Seal® design incorporates an engineered space between the valve body and end fittings. This unique feature allows the valve seats to be restored in-line to a leak-tight condition. This adjustment can be repeated several times to compensate for normal wear.
- Internal design produces a bubble-tight seal.
- Spring-loaded washers create a live-loaded stem assembly for positive sealing.
- Encapsulated body gaskets eliminate cold flow.
- Standard bottom-entry stem provides protection from inadvertent stem removal. Engagement between the slot and ball is specially suited for high torque applications.
- Indexed ball and stem eliminate incorrect reassembly following routine maintenance.
- Optional manual safety nuts maintain stem assembly, live-loading and factory-prepared packing in instances where the handle may be removed for any reason.
- Stainless steel handles with vinyl end covers are designed for a sure grip. Stem markings visually indicate flow direction.
- Stainless steel balls are precision machined and polished to reduce torque and flow resistance, and extend seat life.
- In some processes, a single Multi-Port ball valve can replace several 2-way valves in a piping system, reducing costs and simplifying flow control with actuation. Multi-Port valves can also be tandem or manifold mounted to further centralize control.
- Full-port diameters minimize pressure drops (1/2 - 1", 1-1/2 - 2").
- Transflow, the gradual media flow that occurs as one port opens as another closes, prevents dead-heading and damage to pumps. Note: Transflow will not occur on some bottom entry flow patterns.
- Having either four or five seats ensures tight closure under pressure differentials up to 300 psig.
- Multiple seating in a true Multi-Port valve enables shutoff and directional control in a single valve. Multi-Port valves are ideal for recirculation, mixing, and blending operations.
- Multi-Port valves are ideal for manual or fully automated operation.
- Compact, low profile design facilitates installation in areas with tight space restrictions.
- Stainless steel brackets are strong, durable and corrosion resistant to facilitate wash-down.

OPTIONS — MP SERIES 1

ACTUATION

PBM offers a selection of pneumatic and electric actuation packages. PBM MP Series 1 valves are close-coupled and self-aligning to minimize misalignment. This design improves cycling life and performance, while reducing the total package profile. PBM can easily direct mount a PBM valve on any actuator with a female drive and an ISO bolt pattern.

MP SERIES 1 DIMENSIONAL DATA (INCHES)

Multi-Port valves with Sil-Braze (R-), Female NPT (Q-) and 150# Flange (L-) end fittings.

A	B	C ₁		D ₁		C ₂		D ₂		E	F	G ₁	G ₂	H	I	Approx. Weight (lbs.) Bronze	
Valve Size	Size Code	Port Dia.	Face to Face		C ₁ to Face		Face to Face		C ₂ to Face		Handle Length From C ₁	C ₁ to Top of Handle	C ₁ to Bottom Side Entry	C ₂ to Bottom Bottom Entry	R-Dia.	L-Dia.	
			R-/Q-	L-	R-/Q-	L-	R-/Q-	L-	R-/Q-	L-							
1/2"	C	.62	4.0	CF	2.0	CF	4.0	CF	2.0	CF	6.1	2.8	1.5	CF	.9	3.5	17
3/4"	D	.75	4.0	CF	2.0	CF	4.0	CF	2.0	CF	6.1	2.8	1.5	CF	1.0	3.9	17
1"	E	1.00	4.7	7.3	2.3	3.6	4.5	5.7	2.4	3.6	8.1	5.0	1.6	2.3	1.3	4.3	22
1-1/4"	F	1.00	4.8	CF	2.4	CF	4.5	CF	2.4	CF	8.1	5.0	1.6	2.4	1.7	4.6	23
1-1/2"	G	1.50	6.6	10.6	3.3	5.3	6.0	8.6	3.3	5.3	12.1	5.3	2.3	3.3	1.9	5.0	47
2"	H	2.00	7.8	11.9	3.9	6.0	7.6	9.7	3.9	5.9	12.1	5.8	2.6	3.9	2.4	6.0	70
3"	K	2.25	11.0	14.6	5.5	7.3	9.6	11.4	5.5	7.3	12.1	6.7	4.1	5.5	3.5	7.5	107
4"	L	3.00	CF	17.0	CF	8.5	CF	14.0	CF	8.5	14.1	8.8	5.6	CF	CF	9.0	235

END FITTING SIZE AVAILABILITY

Item	Bronze	Iron	S/S
Female NPT (Q-).....	1/2" - 3"	1-1/2" - 3"	3"
Sil-Braze (R-).....	1/2" - 3"	—	—
150# Flange (L-).....	1-1/2" - 3"	1-1/2" - 4"	4"
Butt Weld (B-).....	—	—	3", 4"
Butt Weld for Tube (E-)* & Extended Butt Weld (F-)*.....	—	—	3", 4"
Socket Weld (U-).....	—	—	3"
Tri-Clamp (X-).....	—	—	3", 4"

NOTES:

- Male NPT, Solder Joint, and Grooved end fittings are also available.
- Iron valves have raised face flanges. Bronze valves have flat face flanges.
- Side entry access.
- 1-1/4", 3", 4", and double angle port are reduced port.
- Drawings are for illustration purposes only. Consult PBM prior to any fabrication or installation work.
- Using a brazed or soldered connection for more than one end fitting on an MP Series valve may complicate maintenance. Provisions must be made to allow removal of end fittings and body from line.
- Approximate weights are estimated based on valves with 150# Flange end fittings.

* For connecting 16 gauge tubing (3" size) and 14 gauge tubing (4" size).

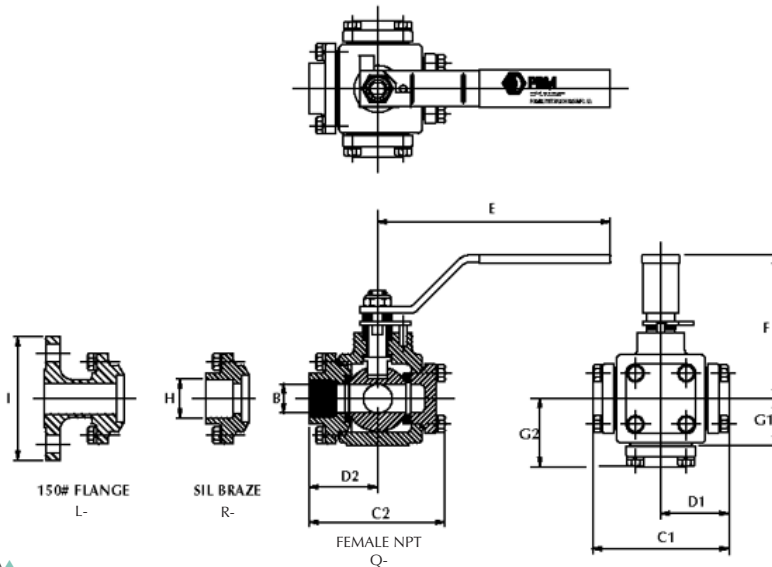

METAL MATERIALS — MP SERIES 1

Process media composition, temperature, and application will dictate appropriate metal and soft part materials. Common valve metals for MP Series 1 valves and their general characteristics are listed below.

Bronze, Alloy No. 836

This metal is the ideal choice for all general-purpose (mildly corrosive) applications. It is versatile and well-suited for steam, air, fresh water, seawater, and oil and gas lines. Some bronze valve components not requiring Sil Braze or welding installation may be impregnated to MIL-I-17563B.

Iron

This popular material provides almost the same high strength of steel, but is more economical. Recommended for mildly corrosive environments such as water, air, natural gas, and oil.

S/S Stainless Steel (Austenitic Grade), A351-GR-CF8M

316 S/S complies with ASTM A-351-CF8M.

316 S/S is exceptionally corrosion-resistant to acidic and basic environments. It does not pit easily and can be polished to a near-mirror finish for the best product release and cleanability.

316L S/S is preferred for sanitary and biotechnological uses.

Sulfur content in cast BWTE (F-) end fittings is controlled to between .005 and .017%, in accordance with ASME BPE-1997.

Low and zero ferrite materials are also available.

Other

See MP Series 4 (page 10) for additional stainless steel and carbon steel. PBM also manufactures valves fabricated from other metals and alloys, including Aluminum.

ALLOWABLE WORKING PRESSURES (PSIG) — MP SERIES

Valve Size	Bronze C83600		Iron		Stainless Steel	
	Temperature Guidelines					
	100°F	450°F	100°F	450°F	100°F	450°F
1/2" & 3/4"	400	350	n/a	n/a	n/a	n/a
1" & 1-1/4"	400	350	n/a	n/a	n/a	n/a
1- 1/2"	400	350	550	450	n/a	n/a
2"	350	300	500	450	n/a	n/a
3"	300	250	450	300	450	300
4"	n/a	n/a	350	250	350	250

NOTES:

1. Temperatures shown are guidelines only, and DO NOT represent the maximum and minimum limits of the valve. Working pressures at temperatures between the minimum and maximum values shown can be interpolated linearly.
2. Seat and seal material ratings may limit allowable pressures and temperatures. For limitations, see page 20.
3. End connections may further limit pressure/temperature ratings. For example, 150# bronze flanges do not meet these ratings.

SEAT AND SEAL MATERIALS — MP SERIES 1

Designation	Description	Color	Purpose
RTFE	Glass Reinforced PTFE ¹ PBM standard for seats, seals and stem packings, except for Igenix valves.	Slightly Off-White	Used in a wide variety of applications.
VTFE	Virgin PTFE ¹ PBM standard for Igenix Sanitary Valves and all cavity fillers.	Bright White	Specified for applications requiring low torque, or where other seat & seal composites might contaminate the process. Ideal for sanitary use. FDA compliant.
TFM	Virgin PTFE modified to provide less porosity and yielding.	White	Provides an FDA compliant material with a ruggedness comparable to RTFE with the lower torque requirements of virgin PTFE. Ideal for sanitary use and for low pressure steam service.
S/STFE	Stainless Steel Reinforced PTFE ¹	Dark Gray	Specified for applications requiring slightly higher pressure/temperature ratings or where the process fluid might absorb glass fibers from RTFE. Slightly higher stem torque than RTFE.
PLUS	Glass, Carbon, and Graphite Reinforced PTFE ¹	Charcoal Black	Ideal for higher temperature/pressure applications and/or steam applications. Three times the cyclic lifetime of RTFE.
UHMWPE	Ultra High Molecular Weight Polyethylene	Glossy Off-White	An excellent abrasion and wear-resistant material. Stem torque is similar to RTFE. Maximum temperature rating is 200°F. FDA compliant.
PEEK	Polyetheretherketone	Putty	Recommended for high temperature (up to 550°F)/long wear applications. Includes a special 17-4 PH Stainless Steel stem to accommodate higher stem torques experienced at higher temperatures. Valves cannot be field retrofitted with PEEK. FDA compliant.
KYNAR [®]	Polyvinylidene Fluoride	Slightly Transparent White	High strength polymer suitable for temperatures to 275°F. Often used in radiation-related service and has been exposure tested to 1,000 megarads with minimal property degradation. FDA compliant.

NOTES:

1. PTFE is Polytetrafluoroethylene.
2. With the exception of PEEK, all seating materials meet the Class VI seat leakage criterion of ANSI/FCI 70-2 and the zero leakage criterion of MSS SP-61. For PEEK seats, a criterion of Class V of ANSI/FC 70-2 applies. PEEK seats are normally not tested with air.
3. Seat and seal materials may be mixed in a valve in order to provide media-compatibility and the appropriate torque, temperature and pressure ratings.

SEAT AND SEAL PRESSURE/TEMPERATURE RATINGS — MP SERIES 1

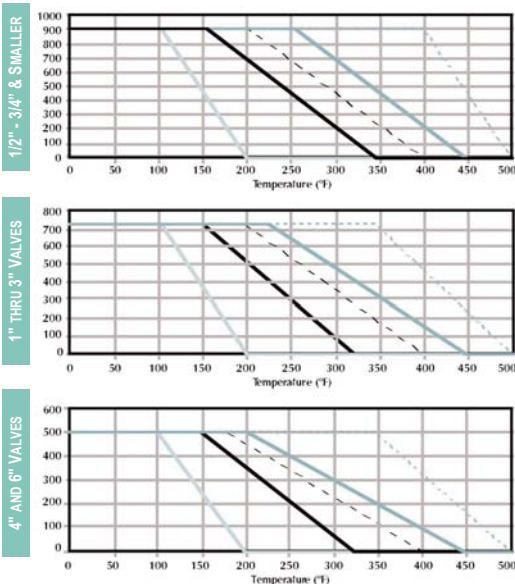

LEGEND

- VTFE
- RTFE & TFM
- S/STFE & PLUS
- PEEK
- UHMWPE

NOTE

- Ratings are for seats and seals only. PBM body ratings are different depending upon valve configuration and body material.

C_V FACTORS — MP SERIES 1

C_V is defined as the number of U.S. gallons of water per minute of ambient temperature water that will flow through a valve at 1 psi pressure drop.

MP SERIES 1 C_V FACTORS (MEASURED IN GPM)

Valve Code	Pipe Size	L-Port	T-Port Through	T-Port Branched	Double L-Port Side Entry	Double L-Port Bottom Entry	Double T-Port Through	Double T-Port Branched
C	1/2"	6.2 ²	10.2 ²	5.5 ²	6.2 ²	5.5 ²	10.2 ²	5.5 ²
D	3/4"	16 ²	23 ²	13.5 ²	16 ²	13.5 ²	23 ²	13.5 ²
E	1"	33	38	24	29	33	38	24
F	1-1/4"	32 ²	36 ²	24 ²	27 ²	31 ²	36 ²	24 ²
G	1-1/2"	78	93	58	67	78	93	58
H	2"	148	176	108	124	148	176	108
K	3"	180	209	135	175	180	209	135
L	4"	300	340	232	283	300	340	232

NOTES:

1. Most values represent MP Series valves with 150# Flange end fittings.
2. MP Series valves with Female NPT end fittings.
3. Flanged end fittings are not available for the F.
4. Full-port through 2" size (except for 1-1/4"). 3", 4", and double angle port are reduced port.

VACUUM AND CYCLE TESTS — MP SERIES 1

Vacuum Testing

PBM valves are ideally suited for vacuum service. For valves intended for vacuum service, PBM offers optional helium leakage tests of the seats and shell. This test consists of an inboard vacuum test where the exterior of the valve is flooded with helium and through valve, inward helium leakage is measured. Also, the seats of the valve are helium leakage tested. PBM valves will meet a leakage rate of 1×10^{-6} cc/sec. helium leakage for both tests.

CYCLE TESTING

The life of a ball valve is dependent upon service conditions and, therefore, impossible to predict. However, PBM cycle-tests valves using 100 psid of ambient temperature water pressure across the seats with the valve in the closed position. These test conditions represent a typical wear-causing force on the seats and packings. PBM also tests valves in a hot water environment up to 200°F and in a steam environment up to 380°F.

Replacement of valve gaskets is recommended at each disassembly. Replacement of other non-moving parts is dictated only by the corrosion caused by the flow media. In most applications, PBM ball valves will operate trouble-free for many years.

VALVE TORQUE - MP SERIES 1

The figures below are presented as a guide to estimating the forces needed to operate a given sized valve, assuming new condition at ambient temperature with a neutral lubricating fluid in the body (such as air or water) and RTFE seats and seals. When using other seat and packing materials, the stem torque should be proportioned according to the as-built torque of that specific material.

If the process involves abrasive or viscous materials, the use of elevated temperatures, or if the seat or ball of the valve is worn, then an additional margin should be added.

When actuating a valve not factory-actuated by PBM, sufficient margin must be added appropriate to the actuator size.

STEM TORQUE VS. DIFFERENTIAL PRESSURE (RTFE SEATS)

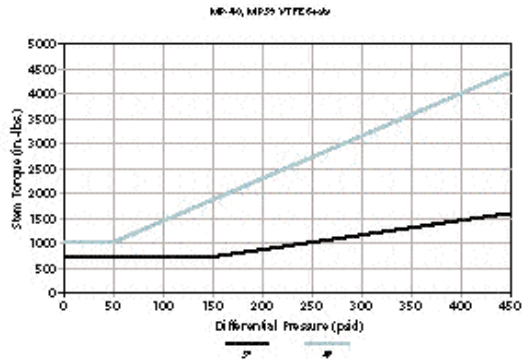
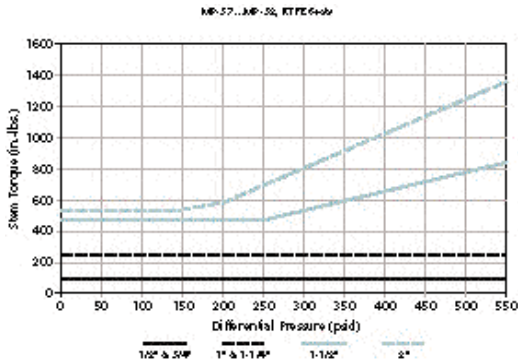

TORQUE VALUES — MP SERIES 1

Stem Torque Values (in.-lb.) for MP Series 1 Ball Valves							
Valve Size	Size Code	Valve Stem Breakaway Torque			Actuator Sizing Torque		
		RTFE, PLUS UHMWPE	S/STFE	VTFE, TFM	RTFE, PLUS UHMWPE	S/STFE	VTFE, TFM
1/2"	C	96	120	77	192	240	154
3/4"	D	96	120	77	192	240	154
1"	E	240	300	192	480	600	384
1-1/4"	F	240	300	192	480	600	384
1-1/2"	G	480	600	384	960	1200	768
2"	H	540	675	432	1080	1350	864
3"	K	720	900	576	1440	1800	1152
4"	L	1020	1275	816	2040	2550	1632

NOTES:

1. Stem torque values shown are minimum values and represent ideal conditions (100 psig or less, ambient temperature, with fluid free of suspended solids and comparable in viscosity to water).
2. If valve has not been factory-actuated by PBM, margin must be added appropriate to the actuator size.
3. Torque values are measured at the stem, NOT at the body bolts.
4. For other seat and seal material torque ratings, consult PBM.

COMPONENTS

Item	Description	Standard Material, PBM Product Series
		MP Series 1
A	Body	Bronze, Iron, or 316 S/S
B	Ball	316 S/S
C	End Fitting	Bronze, Iron, or 316 S/S
C ₁	Blank Fitting	Bronze, Iron, or 316 S/S
D	Handle	300 Series S/S
E	Stop Disc	300 Series S/S
F	Stem	316L S/S
G	Follower	300 Series S/S
H	Seat	RTFE
I	Stem Packing	RTFE
J	Spring Washers (stem)	300 Series S/S
K ₁	End Body Gasket	RTFE
K ₂	Side Body Gasket	RTFE
M	End Fitting Fastener	18-8 S/S
N	Handle Nut	18-8 S/S
O	Lock Washer	18-8 S/S
P	Stop Pin	400 Series S/S
Q	Handle Cover	Vinyl

NOTES:

1. Illustrations and parts lists apply to manually-operated MP/MI Series valves.
2. Other materials may be available.
3. 1/2" and 3/4" MP Series 1 valves have O-rings.
4. For MP Series 1 valves, 1/2" - 3/4" sizes have four spring washers, 1" - 3" sizes have three spring washers, and 4" size has four spring washers.
5. Valves prepared for actuator mounting have three additional spring washers.

MP SERIES 1

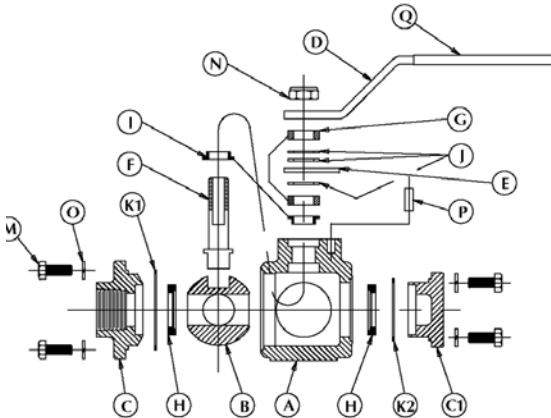

SK-94076A ▲

FLOW PATTERNS — SERIES 1 AND 4 MULTI-PORT VALVES

The PBM Multi-Port Valve is an ideal choice for many piping designs involving switching or mixing. In certain applications, a single MP/MI Series valve can replace two, three or four 2-way valves to reduce cost and space. PBM MP/MI Series valves have a positive seal at every port, and offer a wide variety of possible flow configurations.

MP/MI Series valves are available in 3-, 4-, and 5-way designs. Positive shut off can be achieved on any of the exiting ports. By specifying an Angle Port, Tee Port, Double Angle Port, Double Tee Port or other bottom entry design ball, flow direction can be adjusted for virtually any application.

Ball Port Configuration

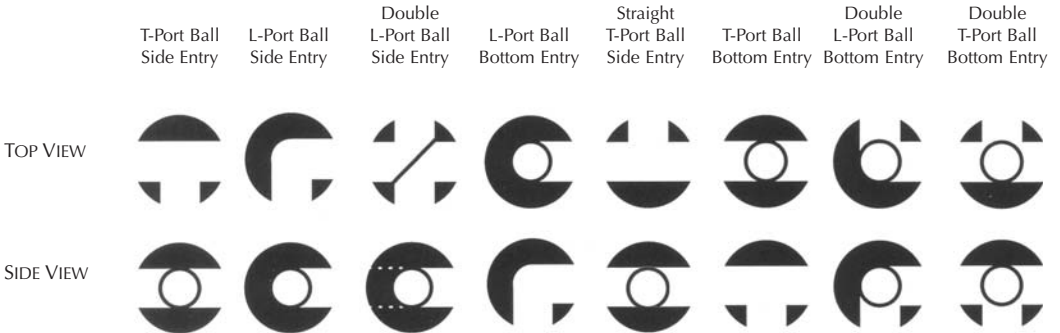

Body Port Configuration

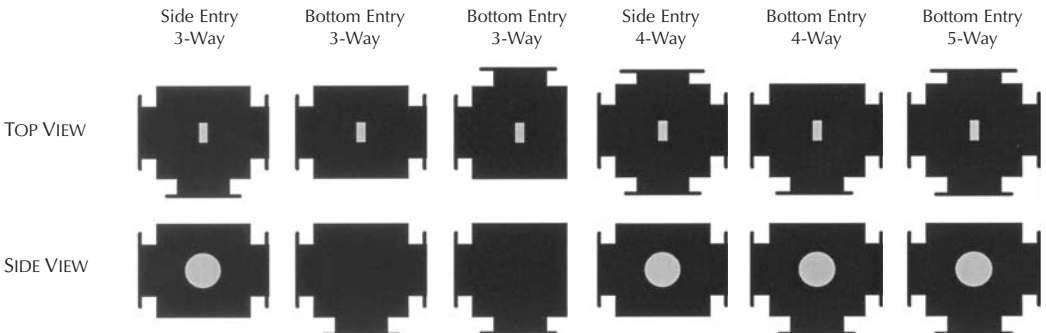

3-WAY MULTI-PORT PATTERNS

3-way Multi-Ports are a popular choice in a variety of industries. A seal at every port distinguishes the 3-way MP/MI Series valve from diverting-type valves. In some applications, the 3-way MP/MI valve can take the place of two or three 2-way valves, with corresponding savings in piping and fittings. For applications requiring simultaneous process line changes, two 3-way MP/MI Series valves may be mounted in tandem and controlled with a single actuator or handle for greater control and additional savings. Additional flow patterns are possible by using manifolds of two or more valves.

The following illustrations show how different ball and port configurations can be used with a 3-way Multi-Port to create a variety of flow patterns. All diagrams show the top view of the MP/MI Series valve as though you were looking down on the stem. White areas indicate the path available for process flow. Shaded areas indicate unused ports for a given flow pattern.

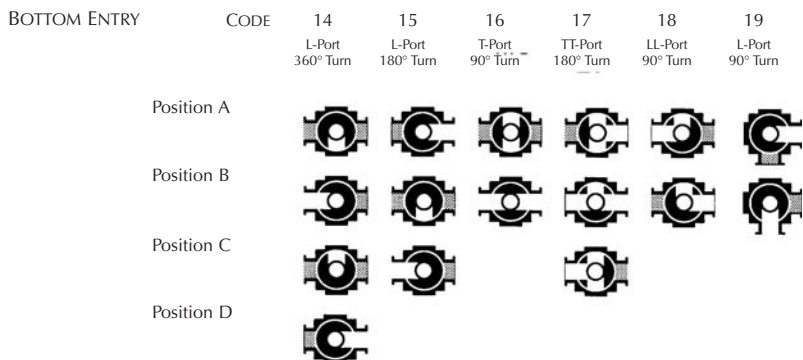
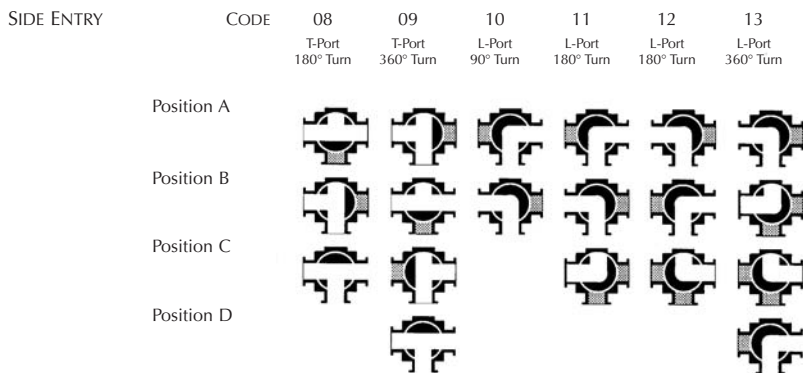
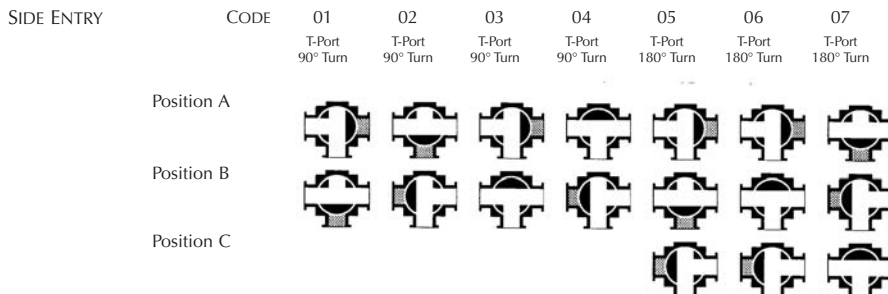

4-WAY MULTI-PORT PATTERNS

4-way Multi-Ports are a true multi-port valve with seals at every port. This design makes the 4-way MP/MI Series ideal for flow switching operations. In some applications, this valve can replace as many as four ordinary 2-way valves, with corresponding savings in piping and fittings.

The following illustrations show how different ball and port configurations create many flow patterns with a single 4-way Multi-Port. All diagrams show the top view of the MP/MI Series valve as though you were looking down on the stem. White areas indicate the path available for process flow. Shaded areas indicate unused ports for a given flow pattern.

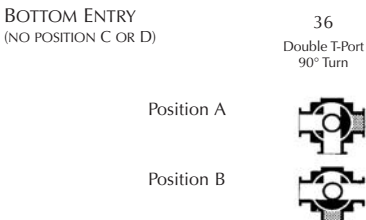
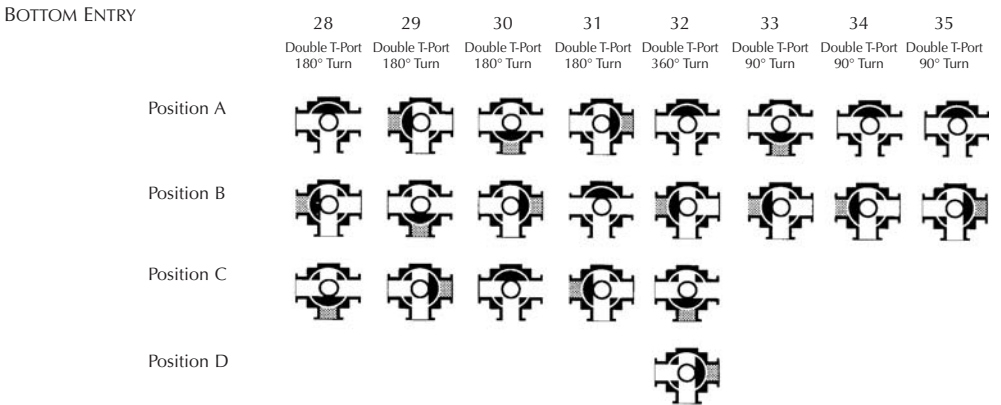
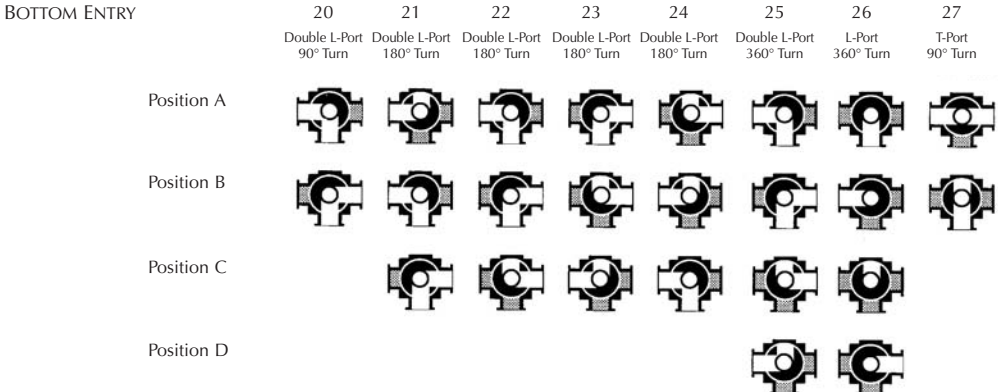

4-WAY MULTI-PORT FLOW PATTERNS

SIDE ENTRY

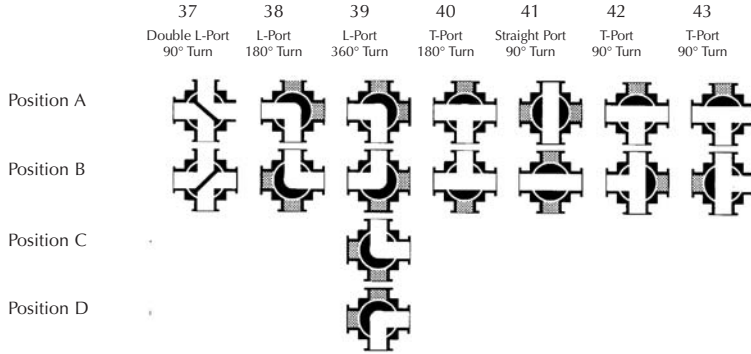

5-WAY MULTI-PORT FLOW PATTERNS

5-way Multi-Ports are 5-seated to provide positive shut-off and flow control at each port. This design is not only versatile, but extremely economical. In some applications, this valve can replace as many as four ordinary 2-way valves, with corresponding savings in piping and fittings.

The following illustrations show available flow patterns with a single 5-way Multi-Port valve. All diagrams show the top view of the MP/MI Series valve as though you were looking down on the stem. White areas indicate the path available for process flow. Shaded areas indicate unused ports for a given flow pattern.

BOTTOM ENTRY

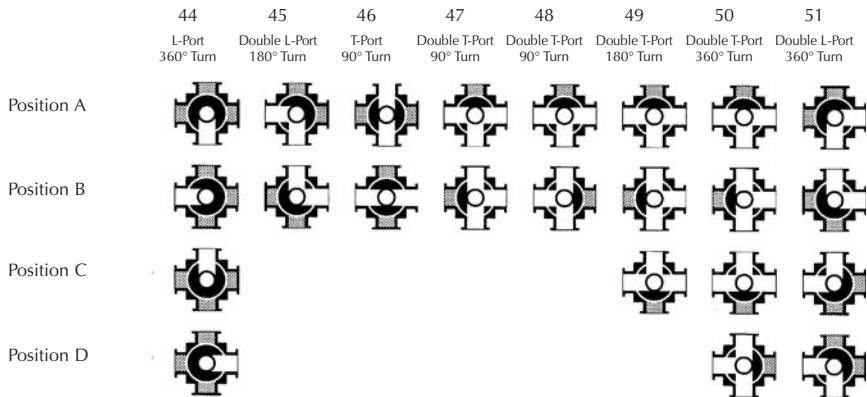

MP & MI SERIES 4 ORDERING INFORMATION

PRODUCT Position 1 + 2	MATERIAL 3 + 4	SIZE 5	SERIES 6	END FITTING 7 + 8	SEAT/SEAL 9
MP Multi-Port MI Igenix Sanitary Multi-Port ¹	E- C/S H- 316 S/S HL* 316L S/S *Only available choice in MI Series. Other materials available.	C 1/2" D 3/4" E 1" F* 1-1/4" G 1-1/2" H 2" K 3" L 4" *MP only.	4 70/80	MP: B- Butt Weld Sch. 40 C- Butt Weld Sch. 5 D- Butt Weld Sch.10 K- Camlock L- 150# Flange M- 300# Flange N- 600# Flange O- Grooved P- Male NPT Q- Female NPT U- Socket Weld MI: A- Acme Bevel E- Butt Weld (Tube) F- Extended Butt Weld (Tube) G- Cherry Burrell Female I Line H- Cherry Burrell Male I-Line J- Cherry Burrell Q-Line V- Socket Weld for Tube X- Tri-Clamp (Tube) MP&MI: -Z No End Fittings If using the code -Z to purchase a center body (or a combination of one end fitting and -Z), you must indicate the end fittings already in-line in order to receive the appropriate hardware. Other end fittings available.	MP & MI: T VTFE w/EPR O-rings A* RTFE w/Viton O-rings U VTFE w/VTFE Filler w/EPR O-rings B RTFE w/VTFE Filler w/Viton O-rings V RTFE w/EPR O-rings C** VTFE w/Viton O-rings W RTFE w/VTFE Filler D VTFE w/VTFE Filler w/EPR O-rings X PLUS w/EPR O-rings E PLUS w/VTFE Filler w/EPR O-rings Y PLUS w/VTFE Filler w/EPR O-rings F PLUS w/VTFE Filler w/Viton O-rings Z TFM w/EPR O-rings G TFM with Viton 0 S/STFE w/EPR O-rings H S/STFE w/VTFE Filler w/EPR O-rings 1 S/STFE w/VTFE Filler w/EPR O-rings I S/STFE w/VTFE Filler w/Viton O-rings 2 TFM w/VTFE Filler w/EPR O-rings J TFM w/VTFE Filler w/Viton O-rings 3 UHMWPE w/EPR O-rings K UHMWPE w/Viton O-rings 4 UHMWPE w/VTFE Filler w/EPR O-rings L UHMWPE w/VTFE Filler w/Viton O-rings 5 UHMWPE w/UHMWPE Filler w/EPR O-rings M UHMWPE w/UHMWPE Filler w/Viton O-rings 6 PEEK / None / Viton 7 VTFE / None / Encap. Viton N PEEK with Perfluoroelastomer O-rings 8 RTFE / None / Encap. Viton O PEEK w/VTFE Filler w/Perfluoroelastomer O-rings 9 Plus / None / Encap. Viton P PEEK w/PEEK Filler w/Perfluoroelastomer O-rings *MP (Series 4) standard. **MI standard. Q Carbon Graphite R Kynar w/Viton O-rings S Kynar w/Kynar Filler w/Viton O-rings

¹ True-Bore™ is Standard

EXAMPLE:

STANDARD							OPTIONS		
Position 1 + 2 Product	3 + 4 Material	5 Size	6 Series	7 + 8 End Fitting	9 Seat/Seal	10 + 11 Flow Pattern	12 Ball/Stem	13 + 14 Operator	15 Polish
MI	HL	H	4	X-	C	19	--	20	F

MIHLH4X-C19-20F is the code for an Igenix Multi-Port, 316L S/S, 2" valve, series 4, with Tri-Clamp ends, VTFE seats and seals, flow pattern #19, no ball/stem choice, double acting actuator 80 psi with 22 Ra Max. I.D. polish and electropolish.

WORK SPACE: FOR YOU TO FILL IN THE BLANKS

STANDARD							OPTIONS		
Position 1 + 2 Product	3 + 4 Material	5 Size	6 Series	7 + 8 End Fitting	9 Seat/Seal	10 + 11 Flow Pattern	12 Ball/Stem	13 + 14 Operator	15 Polish

FLOW PATTERN 10 + 11/Ball & Port Configuration	BALL/STEM 12	OPERATOR 13 + 14	POLISH 15
01 3-Way, T-Port Ball, Side Entry, 90° turn	A w/2" Stem Extension	01 without Handle	A 18-23 R _a I.D.
02 3-Way, T-Port Ball, Side Entry, 90° turn	B w/4" Stem Extension	02 without Handle, prepared for actuator mounting	B 27-32 R _a O.D.
03 3-Way, T-Port Ball, Side Entry, 90° turn	C w/6" Stem Extension	03 with Handle, prepared for actuator mounting	C 18-23 R _a I.D. & 27 32 Ra O.D.
04 3-Way, T-Port Ball, Side Entry, 90° turn	D w/ 2" stem Extension and internal & external grounding	04 with Locking Handle	D 14-18 R _a I.D.
05 3-Way, T-Port Ball, Side Entry, 180° turn	E w/4" stem Extension and internal & external grounding	05 w/ Stainless Oval Handwheel	E 8-10 Ra I.D.
06 3-Way, T-Port Ball, Side Entry, 180° turn	F w/ int. & ext. grounding	08 with Gear Operator	F 22 R _a Max. I.D. + Electropolish
07 3-Way, T-Port Ball, Side Entry, 180° turn	G with 17-4PH stem	10 Manual Spring Return Handle	G 18 R _a Max. I.D. + Electropolish
08 3-Way, T-Port Ball, Side Entry, 180° turn	I with Monel ball	11 with Fusible Link Spring Return Handle	H 8 R _a Max. I.D. + Electropolish
09 3-Way, T-Port Ball, Side Entry, 360° turn	J with 932 Bronze ball	16 with Locking Handle, Actr. Mt. Body	I 63 R _a Max. I.D.
10 3-Way, L-Port Ball, Side Entry, 90° turn	K with Monel stem & followers	17 with Ext. Locking Oval Handwheel	K 6-8 R _a I.D.
11 3-Way, L-Port Ball, Side Entry, 180° turn	L with Monel ball, stem and followers	20 with D/A 80 psig actuator	L 14-18 R _a I.D. & 27 32 R _a O.D. + Electropolish
12 3-Way, L-Port Ball, Side Entry, 180° turn	M with Aluminium ball	21 with D/A 80 psig Actr., NEMA 4 limit switch	
13 3-Way, L-Port Ball, Side Entry, 360° turn	N with 922 Bronze ball	22 with D/A 80 psig Actr., NEMA 4 solenoid	
14 3-Way, L-Port Ball, Bottom Entry, 360° turn	O w/ Hastelloy C-276 ball	23 with D/A 80 psig Actr., NEMA 4 limit switch and solenoid	
15 3-Way, L-Port Ball, Bottom Entry, 180° turn	P w/ Hastelloy C-276 ball, stem and followers	24 with D/A 80 psig Actr., NEMA 7 limit switch	
16 3-Way, T-Port Ball, Bottom Entry, 90° turn	Q with 922 Bronze ball, Monel stem and followers	25 with D/A 80 psig Actr., NEMA 7 solenoid	
17 3-Way, Double T-Port Ball, Bottom Entry, 180° turn	R with Monel stem, followers and bolting	26 with D/A 80 psig Actr., NEMA 7 limit switch and solenoid	
18 3-Way, Double L-Port Ball, Bottom Entry, 90° turn	S w/ Monel ball, stem, followers and bolting	27 with D/A 60 psig Actuator	
19 3-Way, L-Port Ball, Bottom Entry, 90° turn	T w/ 932 Bronze ball, Monel stem and followers, and SIL-BRZ bolting	28 D/A 60 psig Actuator, NEMA 4 limit switch	
20 4-Way, Double L-Port Ball, Bottom Entry, 90° turn		29 D/A 60 psig Actuator, NEMA 4 solenoid	
21 4-Way, Double L-Port Ball, Bottom Entry, 180° turn		30 D/A 60 psig Actuator, NEMA 4 limit switch and solenoid	
22 4-Way, Double L-Port Ball, Bottom Entry, 180° turn		31 D/A 60 psig Actuator, NEMA 7 limit switch	
23 4-Way, Double L-Port Ball, Bottom Entry, 180° turn		32 D/A 60 psig Actuator, NEMA 7 solenoid	
24 4-Way, Double L-Port Ball, Bottom Entry, 180° turn		33 D/A 60 psig Actuator, NEMA 7 limit switch and solenoid	
25 4-Way, Double L-Port Ball, Bottom Entry, 360° turn		34 S/R 80 psig Actuator	
26 4-Way, L-Port Ball, Bottom Entry, 360° turn		35 S/R 80 psig Actuator, NEMA 4 limit switch	
27 4-Way, T-Port Ball, Bottom Entry, 90° turn		36 S/R 80 psig Actuator, NEMA 4 solenoid	
28 4-Way, Double T-Port Ball, Bottom Entry, 180° turn		37 S/R 80 psig Actuator, NEMA 4 limit switch and solenoid	
29 4-Way, Double T-Port Ball, Bottom Entry, 180° turn		38 S/R 80 psig Actuator, NEMA 7 limit switch	
30 4-Way, Double T-Port Ball, Bottom Entry, 180° turn		39 S/R 80 psig Actuator, NEMA 7 solenoid	
31 4-Way, Double T-Port Ball, Bottom Entry, 180° turn		40 S/R 80 psig Actuator, NEMA 7 limit switch and solenoid	
32 4-Way, Double T-Port Ball, Bottom Entry, 360° turn		41 S/R 60 psig Actuator	
33 4-Way, Double T-Port Ball, Bottom Entry, 90° turn		42 S/R 60 psig Actuator, NEMA 4 limit switch	
34 4-Way, Double T-Port Ball, Bottom Entry, 90° turn		43 S/R 60 psig Actuator, NEMA 4 solenoid	
35 4-Way, Double T-Port Ball, Bottom Entry, 90° turn		44 S/R 60 psig Actuator, NEMA 4 limit switch and solenoid	
36 4-Way, Double T-Port Ball, Bottom Entry, 90° turn		45 S/R 60 psig Actuator, NEMA 7 limit switch	
37 4-Way, Double L-Port Ball, Side Entry, 90° turn		46 S/R 60 psig Actuator, NEMA 7 solenoid	
38 4-Way, L-Port Ball, Side Entry, 180° turn		47 S/R 60 psig Actuator, NEMA 7 limit switch and solenoid	
39 4-Way, L-Port Ball, Side Entry, 360° turn		Other actuator options available.	
40 4-Way, T-Port Ball, Side Entry, 180° turn			
41 4-Way, Straight Port Ball, Side Entry, 90° turn			
42 4-Way, T-Port Ball, Side Entry, 90° turn			
43 4-Way, T-Port Ball, Side Entry, 90° turn			
44 5-Way, L-Port Ball, Bottom Entry, 360° turn			
45 5-Way, Double L-Port Ball, Bottom Entry, 180° turn			
46 5-Way, T-Port Ball, Bottom Entry, 90° turn			
47 5-Way, Double T-Port Ball, Bottom Entry, 90° turn			
48 5-Way, Double T-Port Ball, Bottom Entry, 90° turn			
49 5-Way, Double T-Port Ball, Bottom Entry, 180° turn			
50 5-Way, Double T-Port Ball, Bottom Entry, 360° turn			
51 5-Way, Double L-Port Ball, Bottom Entry, 360° turn			

SEE PAGES 24-27 for flow patterns and configurations.

MP SERIES 1 ORDERING INFORMATION

PRODUCT Position 1 + 2	MATERIAL 3 + 4	SIZE 5	SERIES 6	END FITTING 7 + 8	SEAT/SEAL 9
MP Multi-Port	B- 836 Bronze D- Iron H- 316 S/S* Other materials available. * 3", 4" sizes only	C 1/2" D 3/4" E 1" F 1-1/4" G 1-1/2" H 2" K 3" L 4" M 6" Iron (D-) available in sizes 1-1/2" - 4". Bronze (B-) available in sizes 1/2" - 4". 316 S/S (H-) available in 3", 4" & 6". C/S (E-) available in 6".	1 30/40	L- 150# Flange M- 300# Flange Q- Female NPT R- Sil Braze S- Sil Braze 1 Groove T- Solder Joint -Z No End Fittings If using the code -Z to purchase a center body (or a combination of one end fitting and -Z), you must indicate the end fittings already in-line in order to receive the appropriate hardware. Other end fittings available.	A* RTFE C VTFE E PLUS G TFM H S/STFE K UHMWPE N PEEK Q Carbon Graphite R Kynar *MP (Series 1) standard.

EXAMPLE:

STANDARD							OPTIONS		
Position 1 + 2 Product	3 + 4 Material	5 Size	6 Series	7 + 8 End Fitting	9 Seat/Seal	10 + 11 Flow Pattern	12 Ball/Stem	13 + 14 Operator	15 Polish
MP	B-	H	1	Q-	A	04	G	08	--

MPB-H1Q-A04G08 is the code for a Multi-Port, 836 bronze, 2" valve, series 1, with female NPT ends, RTFE seats and seals, flow pattern #04, with 17-4 PH 300 S/S stem and manual gear operator, and no polish.

WORK SPACE: FOR YOU TO FILL IN THE BLANKS

STANDARD							OPTIONS		
Position 1 + 2 Product	3 + 4 Material	5 Size	6 Series	7 + 8 End Fitting	9 Seat/Seal	10 + 11 Flow Pattern	12 Ball/Stem	13 + 14 Operator	15 Polish

FLOW PATTERN 10 + 11/Ball & Port Configuration	BALL/STEM 12	OPERATOR 13 + 14	POLISH 15
01 3-Way, T-Port Ball, Side Entry, 90° turn	A w/2" Stem Extension	01 without Handle	A 18-23 R _a I.D.
02 3-Way, T-Port Ball, Side Entry, 90° turn	B w/4" Stem Extension	02 without Handle, prepared for actuator mounting	B 27-32 R _a O.D.
03 3-Way, T-Port Ball, Side Entry, 90° turn	C w/6" Stem Extension	03 with Handle, prepared for actuator mounting	C 18-23 R _a I.D. & 27-32 R _a O.D.
04 3-Way, T-Port Ball, Side Entry, 90° turn	D w/ 2" stem Extension and internal & external grounding	04 with Locking Handle	D 14-18 R _a I.D.
05 3-Way, T-Port Ball, Side Entry, 180° turn	E w/4" stem Extension and internal & external grounding	05 w/ Stainless Oval Handwheel	E 8-10 R _a I.D.
06 3-Way, T-Port Ball, Side Entry, 180° turn	F w/ int. & ext. grounding	08 with Gear Operator	F 22 R _a Max. I.D. + Electropolish
07 3-Way, T-Port Ball, Side Entry, 180° turn	G with 17-4PH stem	10 Manual Spring Return Handle	G 18 R _a Max. I.D. + Electropolish
08 3-Way, T-Port Ball, Side Entry, 180° turn	I with Monel ball	11 with Fusible Link Spring Return Handle	H 8 R _a Max. I.D. + Electropolish
09 3-Way, T-Port Ball, Side Entry, 360° turn	J with 932 Bronze ball	16 with Locking Handle, Actr. Mnt. Body	I 63 R _a Max. I.D.
10 3-Way, L-Port Ball, Side Entry, 90° turn	K with Monel stem & followers	17 with Ext. Locking Oval Handwheel	K 6-8 R _a I.D.
11 3-Way, L-Port Ball, Side Entry, 180° turn	L with Monel ball, stem and followers	20 with D/A 80 psig actuator	L 14-18 R _a I.D.
12 3-Way, L-Port Ball, Side Entry, 180° turn	M with Aluminum ball	21 with D/A 80 psig Actr., NEMA 4 limit switch	& 27-32 R _a O.D. + Electropolish
13 3-Way, L-Port Ball, Side Entry, 360° turn	N with 922 Bronze ball	22 with D/A 80 psig Actr., NEMA 4 solenoid	
14 3-Way, L-Port Ball, Bottom Entry, 360° turn	O w/ Hastelloy C-276 ball	23 with D/A 80 psig Actr., NEMA 4 limit switch and solenoid	
15 3-Way, L-Port Ball, Bottom Entry, 180° turn	P w/ Hastelloy C-276 ball, stem and followers	24 with D/A 80 psig Actr., NEMA 7 limit switch	
16 3-Way, T-Port Ball, Bottom Entry, 90° turn	Q with 922 Bronze ball, Monel stem and followers	25 with D/A 80 psig Actr., NEMA 7 solenoid	
17 3-Way, Double T-Port Ball, Bottom Entry, 180° turn	R with Monel stem, followers and bolting	26 with D/A 80 psig Actr., NEMA 7 limit switch and solenoid	
18 3-Way, Double L-Port Ball, Bottom Entry, 90° turn	S w/ Monel ball, stem, followers and bolting	27 with D/A 60 psig Actuator	
19 3-Way, L-Port Ball, Bottom Entry, 90° turn	T w/ 932 Bronze ball, Monel stem and followers, and SIL-BRZ bolting	28 D/A 60 psig Actuator, NEMA 4 limit switch	
20 4-Way, Double L-Port Ball, Bottom Entry, 90° turn		29 D/A 60 psig Actuator, NEMA 4 solenoid	
21 4-Way, Double L-Port Ball, Bottom Entry, 180° turn		30 D/A 60 psig Actuator, NEMA 4 limit switch and solenoid	
22 4-Way, Double L-Port Ball, Bottom Entry, 180° turn		31 D/A 60 psig Actuator, NEMA 7 limit switch	
23 4-Way, Double L-Port Ball, Bottom Entry, 180° turn		32 D/A 60 psig Actuator, NEMA 7 solenoid	
24 4-Way, Double L-Port Ball, Bottom Entry, 180° turn		33 D/A 60 psig Actuator, NEMA 7 limit switch and solenoid	
25 4-Way, Double L-Port Ball, Bottom Entry, 360° turn		34 S/R 80 psig Actuator	
26 4-Way, L-Port Ball, Bottom Entry, 360° turn		35 S/R 80 psig Actuator, NEMA 4 limit switch	
27 4-Way, T-Port Ball, Bottom Entry, 90° turn		36 S/R 80 psig Actuator, NEMA 4 solenoid	
28 4-Way, Double T-Port Ball, Bottom Entry, 180° turn		37 S/R 80 psig Actuator, NEMA 4 limit switch and solenoid	
29 4-Way, Double T-Port Ball, Bottom Entry, 180° turn		38 S/R 80 psig Actuator, NEMA 7 limit switch	
30 4-Way, Double T-Port Ball, Bottom Entry, 180° turn		39 S/R 80 psig Actuator, NEMA 7 solenoid	
31 4-Way, Double T-Port Ball, Bottom Entry, 180° turn		40 S/R 80 psig Actuator, NEMA 7 limit switch and solenoid	
32 4-Way, Double T-Port Ball, Bottom Entry, 360° turn		41 S/R 60 psig Actuator	
33 4-Way, Double T-Port Ball, Bottom Entry, 90° turn		42 S/R 60 psig Actuator, NEMA 4 limit switch	
34 4-Way, Double T-Port Ball, Bottom Entry, 90° turn		43 S/R 60 psig Actuator, NEMA 4 solenoid	
35 4-Way, Double T-Port Ball, Bottom Entry, 90° turn		44 S/R 60 psig Actuator, NEMA 4 limit switch and solenoid	
36 4-Way, Double T-Port Ball, Bottom Entry, 90° turn		45 S/R 60 psig Actuator, NEMA 7 limit switch	
37 4-Way, Double L-Port Ball, Side Entry, 90° turn		46 S/R 60 psig Actuator, NEMA 7 solenoid	
38 4-Way, L-Port Ball, Side Entry, 180° turn		47 S/R 60 psig Actuator, NEMA 7 limit switch and solenoid	
39 4-Way, L-Port Ball, Side Entry, 360° turn		Other actuator options available.	
40 4-Way, T-Port Ball, Side Entry, 180° turn			
41 4-Way, Straight Port Ball, Side Entry, 90° turn			
42 4-Way, T-Port Ball, Side Entry, 90° turn			
43 4-Way, T-Port Ball, Side Entry, 90° turn			
44 5-Way, L-Port Ball, Bottom Entry, 360° turn			
45 5-Way, Double L-Port Ball, Bottom Entry, 180° turn			
46 5-Way, T-Port Ball, Bottom Entry, 90° turn			
47 5-Way, Double T-Port Ball, Bottom Entry, 90° turn			
48 5-Way, Double T-Port Ball, Bottom Entry, 90° turn			
49 5-Way, Double T-Port Ball, Bottom Entry, 180° turn			
50 5-Way, Double T-Port Ball, Bottom Entry, 360° turn			
51 5-Way, Double L-Port Ball, Bottom Entry, 360° turn			
SEE PAGES 24-27 for flow patterns and configurations.			